

# Technical Specifications

## Gendex GXDP-700™ Series Digital Panoramic X-ray System

<b>Anode Voltage</b>	57-90 kV
<b>Anode Current</b>	max 16 mA
<b>Line Voltage</b>	100-240 V AC / 220-240 V AC, 50/60 Hz
<b>Maximum Line Power Rating</b>	10 A at 100/120 V, 4 A at 220/240 V
<b>Weight</b>	440 lbs (200 kg), with Ceph arm 551 lbs (250 kg)
<b>Warranty</b>	2 years

<b>GXDP-700 2D sensor</b>	
<b>Focal Spot</b>	0.5 mm, IEC 336 (1982)
<b>Exposure Time</b>	14.4 sec. for child pan, 16.4 sec. for standard pan, 10.6 sec. for TMJ, 11.9 sec. for Bitewing
<b>Image Pixel Size</b>	100 µm
<b>Active Sensor Height (Pan)</b>	151 mm

<b>GXDP-700 3D sensor</b>	
<b>Image Volume Sizes</b>	61 mm (h) x 41 mm (d), 61 mm (h) x 78 mm (d)
<b>Scan Time</b>	10 - 20 sec.
<b>Exposure Time</b>	2.34 - 12.5 sec. pulsed x-ray
<b>Image Pixel Size</b>	200 µm

The Gendex GXDP-700 is a Class I Laser Product and complies with FDA performance standards for laser products except for deviations pursuant to Laser Notice No. 50, dated June 24, 2007. Laser radiation is emitted during positioning (Wavelength: 650nm, Output Power ≤1mW) and users and patients should not stare into the beam.

### Unit Dimensions

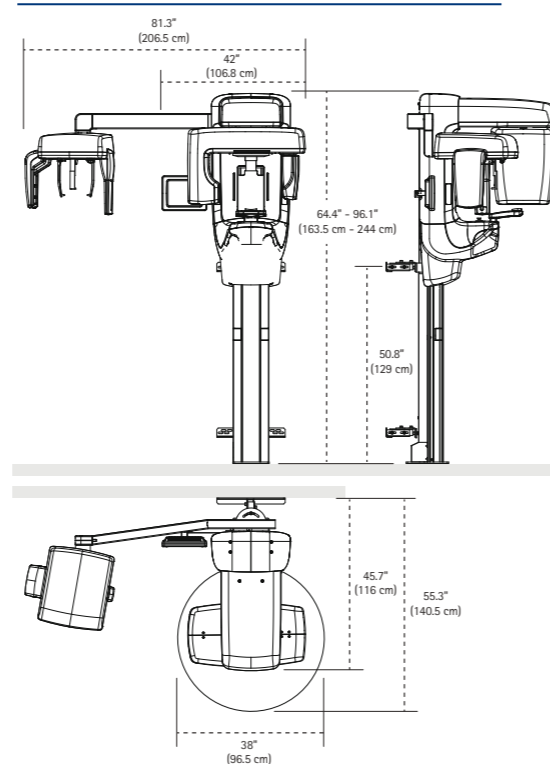

**GX DP-700™**

**NEW from Gendex!**

PC Requirements	Minimum	Recommended
<b>Operating System</b>	Microsoft® Windows® XP with service pack SP3	Microsoft® Windows® 7 Professional 64 bit
<b>Driver</b>	GxPicture 3.2 or higher	GxPicture 3.2 or higher
<b>Standards</b>	In compliance with the UL/IEC/EN 60950 standard	

Microsoft®, Windows®, Intel®, Celeron®, NVIDIA® and Quadro® are trademarks of their respective owners.

GXDP-700 and GXDP-700 C models		
<b>Processor</b>	Intel Celeron® M 1.6 GHz	Intel® Core™ 2 Duo 2.4 GHz
<b>Memory</b>	2 GB	4 GB
<b>Hard Disk</b>	250 GB	500 GB
<b>Display Settings</b>	1024 x 768 at 32 bit true color	1280 x 1024 at 32 bit true color
<b>Video Memory</b>	1 GB	4 GB

GXDP-700 S and GXDP-700 SC models		
<b>Processor</b>	Intel® Core™ 2 Duo 2.5 GHz	Intel® Core™ i7 900 series
<b>Memory</b>	3 GB	4 GB
<b>Hard Disk</b>	500 GB	1 TB
<b>Display Settings</b>	1280 x 1024 at 32 bit true color	1600 x 1200 at 32 bit true color
<b>Video Card</b>	GTX 460 NVIDIA® Quadro® GPU, FX 3800 NVIDIA® Quadro®	

**The Power Of Choice...Pan. Ceph. 3D.  
Your Imaging Future Starts Today.**

- Cone Beam 3D Imaging Systems
- Panoramic X-ray Systems
  - Intraoral X-ray Systems
  - Digital Intraoral Sensors
  - Digital X-ray Phosphor Plates
  - Intraoral Cameras
  - Imaging Software



**KaVo Dental GmbH**  
D-88400 Biberach/Riss  
Telefon +49 7351 56-0  
Fax +49 7351 56-1488  
www.gendex-dental.com

Become a fan  
[facebook.com/KaVoGlobal](https://facebook.com/KaVoGlobal)

Follow us  
[youtube.com/user/KaVoDentalGmbH](https://youtube.com/user/KaVoDentalGmbH)

Mat.-Nr. 1.008.7289 en 07/12 ©Gendex Dental Systems





### A Powerful System From A Strong History Of Innovation

For over a century, Genex has been dedicated to imaging excellence and providing total solutions that improve the clinical lives of doctors. This legacy of imaging solutions through award-winning products and extensive field testing now culminates in our latest innovation...the GXDP-700™ Series, a 3-in-1 system that can help you achieve your clinical goals.

**GXDP-700™**  
S E R I E S

### General Surveys

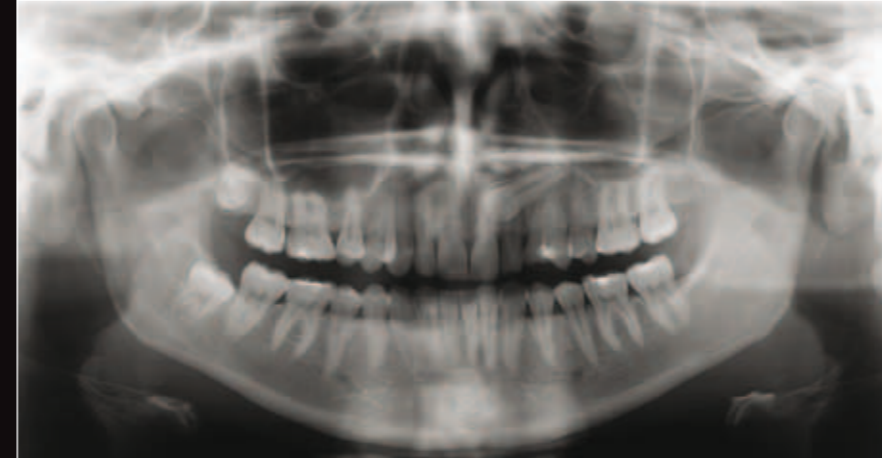

*Pans for general surveys and progress checks during orthodontic treatment*

### Cephalometric Analysis



*Cephalometrics to facilitate analysis as well as evaluation of treatment and growth changes*

### Implants, Extractions, Root Evaluations



*3D for nerve mapping, accurate measurements, precise tooth location, and views from every angle*

### Flexibility



### The Power Of Flexibility

The GXDP-700™ Series allows different types of imaging for a wide range of clinical situations, giving you the flexibility to capture the images necessary for the procedures you perform. From general preventative care to implants, extractions, root treatment, or orthodontics, this modular system can be upgraded to cephalometric, 3D SFOV (small field-of-view), or both. So not only do you have the choice of a full complement of 2D panoramic imaging, you have the freedom to expand as your practice grows.

Clinicians can adeptly move from 2D to 3D like never before! With the touchscreen panel, choosing from a variety of region-specific 2D scan options or selecting the location and size of 3D FOV is simple and convenient. The GXDP-700™ offers 33 panoramic options — 11 projections for three patient sizes, two 3D volume sizes plus a dose-saving scout view, and the ability to add cephalometrics — 15 options, 5 projections for three patient sizes.



# Repeatability



## Pan. Ceph. 3D.

Along with the ability to transform from 2D Panoramics to Cephalometrics to 3D, the GXDP-700 Series gives clinicians dependable image capture of a wide variety of radiographs. These images are valuable for diagnosis and treatment planning of caries, root investigation, orthodontics, implants, and other surgical procedures, as well as patient education. The carefully engineered design of the GXDP-700 Series provides:

- Flexibility**  
Capture the images necessary for the procedures you perform
- Repeatability**  
Acquire high-quality images, easily and consistently
- Upgradability**  
Advanced imaging to accommodate additional treatment offerings

## The Power Of Repeatability

We understand the importance of providing a fast, simple and straightforward imaging solution for your team that delivers consistent images to you. With the GXDP-700™ Series, you'll benefit from a powerful product that meets this vital goal — high-quality imaging results, time after time.

With built-in functionality and thoughtfully developed tools, including EasyPosition™ and SmartMotion™, any member of your clinical team can acquire clear, detailed images, easily and consistently. This type of repeatability gives your staff the power of confidence and you the power of diagnosis.

## SmartMotion™

Adaptable motion technology adjusts the x-ray beam allowing for changes in anatomical curvatures to optimize image quality. Adding to this quality is SmartMotion's spinal compensation — the motion slows at the appropriate point to minimize spinal artifacts.

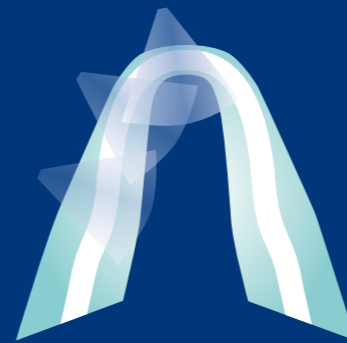

## EasyPosition™

Five user-friendly tools allow clinical team members to quickly and effortlessly position the patient.



Easy-to-access column controls



Sturdy chin support



Ergonomically designed handgrips help enhance patient comfort



Fully adjustable head support



Laser alignment lights accurately guide patient positioning

# GX DP-700™

## Your clear path for growth begins with the GXDP-700 Series.

The GXDP-700 Series begins with a robust system with sophisticated styling and an ergonomic design. Beneath its beautiful, high-gloss exterior the system sports state-of-the-art electronics, heavy-duty components, and a sturdy, steel telescoping column. Gendex engineering and reliability provide its long-lasting dependable performance.

Inherent to all system configurations, and exclusive to Gendex, is SmartLogic™ Technology. When taking all 2D and 3D images, SmartLogic stores the most frequently used settings so setup time is reduced and the workflow is optimized.

The intuitive functionality of the GXDP-700's touchscreen makes choosing imaging selections simple, efficient, and fast. Your clinical team members are sure to appreciate the easy-to-read screens with their easy-to-understand graphics.



### Pan

The GXDP-700's panoramic imaging includes a wide variety of projections, including bitewing and TMJ, to expand your radiographic capabilities. Other projections consist of orthogonals, frontal dentition, and sinus, and most views also allow for the selection of either right or left exposures.

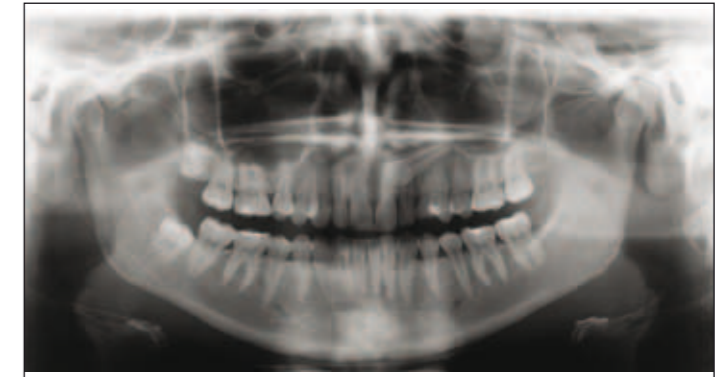

Standard Adult Panoramic

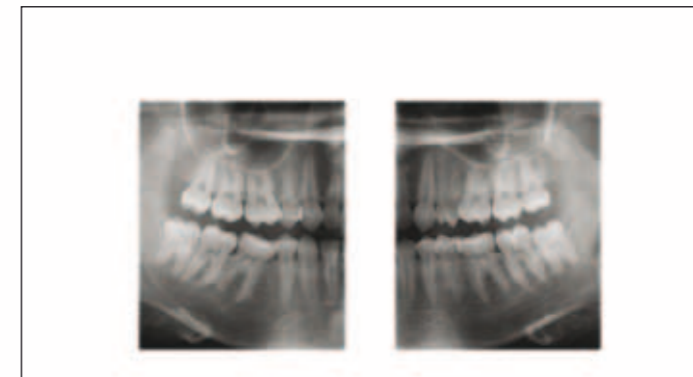

Bitewing

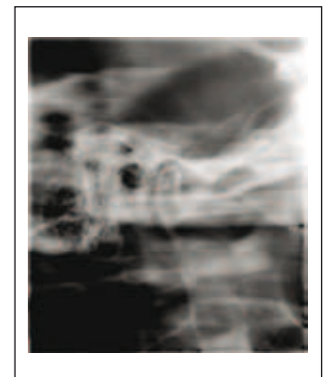

Lateral TMJ

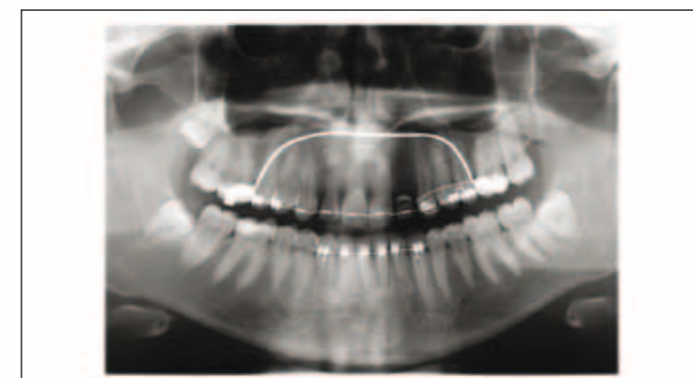

Orthogonal Dentition

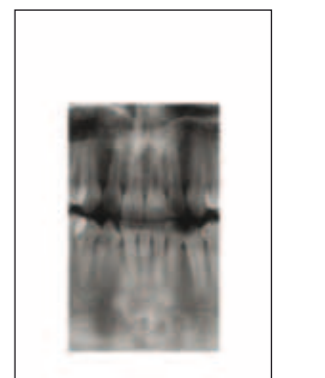

Frontal Dentition

33 Panoramic projections, eleven selections for three patient sizes

## Ceph



15 2D Cephalometric projections – five selections for three patient sizes



Latero-Lateral



Antero-Posterior

Frontal and lateral cephalometric flexibility for orthodontic treatment planning

## Single Or Dual Sensor Solutions

With the 2D cephalometric upgrade, Gendex offers even more options. Choose a single sensor to move between panoramic and ceph to maximize your investment, or choose two sensors to increase efficiency in your workflow.



## Upgradability

### The Power Of Upgradability

The GXDP-700 Series is the perfect solution for progressive dentistry – dynamic, modular and expandable. As your practice grows and your procedure offerings expand, you can upgrade on your timeline and within your budget, seamlessly and affordably.

### One Innovative System – Four Modular Options

**A complete solution that protects your investment and peace-of-mind.**

Now or in the future, with field upgradable options, you're ready to take this hard-working pan to the next level of cephalometric, 3D SFOV imaging, or both. We've made it easy to build the system that's right for you:

### GXDP-700™ SERIES

- GXDP-700 Panoramic Imaging System
- GXDP-700 C Panoramic and Cephalometric Imaging System
- GXDP-700 S Panoramic and 3D CBCT Imaging System
- GXDP-700 SC Panoramic, 3D CBCT and Cephalometric Imaging System

## 3D



Select the FocusView scan size for a 4 cm diameter (d) x 6 cm height (h) standard field-of-view for isolating a specific area



Use the optional FocusView EV scan size of 8 cm d x 6 cm h field-of-view to capture a larger region of interest



FocusView



FocusView EV

## The Power Of 3D

From extractions to endodontics, orthodontics to implants, 3D scans provide valuable information vital to diagnosis and determining the best course of treatment. With an automated 2D/3D sensor exchange, two sensors that rotate to capture both 3D and panoramic, clinicians merely press a button to switch from taking 3D images to 2D panoramic projections. There's no need to remove the panoramic sensor.

Your 3D workflow couldn't be easier. After positioning the patient, use PerfectScout™ to zone in on the area of interest. This unique feature captures two, low-dose perpendicular images which display on the touchscreen panel. From there, the area of interest can be targeted – simply drag the crosshair into position, and then, initiate the scan.

### PerfectScout™



## Ortho-Surgical Management of Impactions



## Root Investigation, Endo Retreats

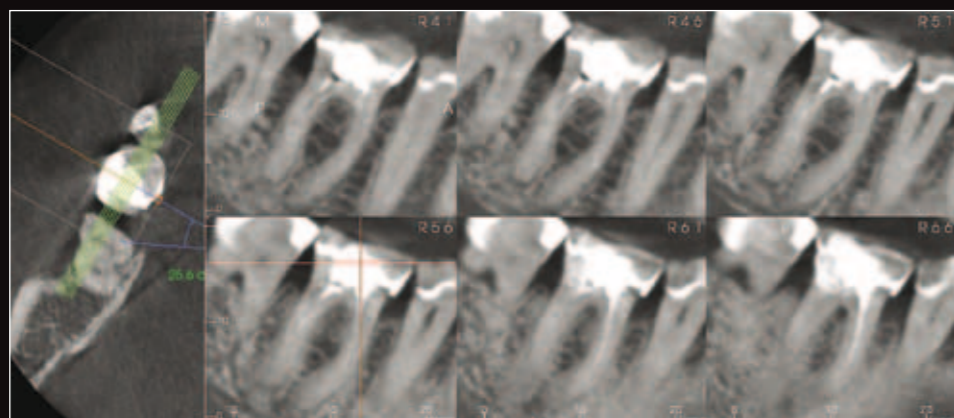

## Surgical Planning – Simple Extractions to Bony Impactions

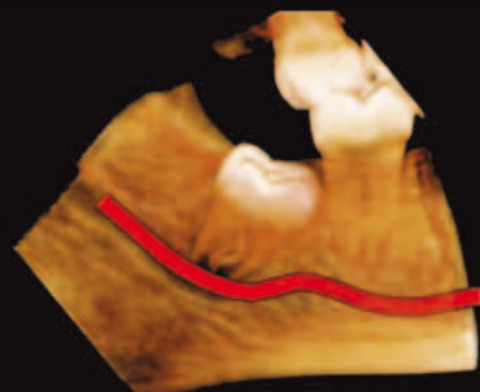

## Scan. Plan. Treat.

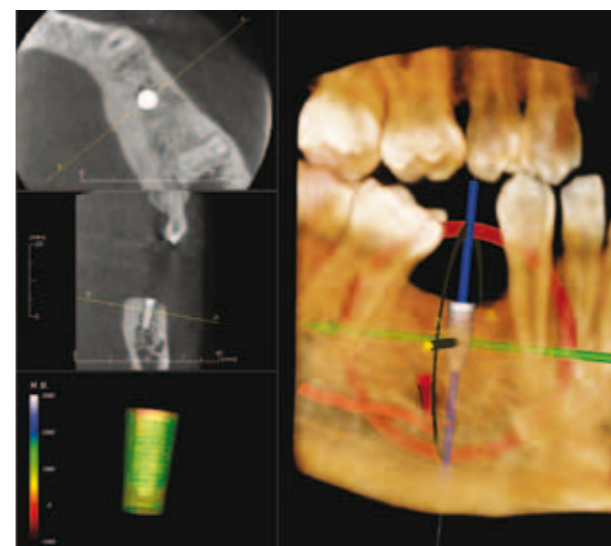

Implant Plan

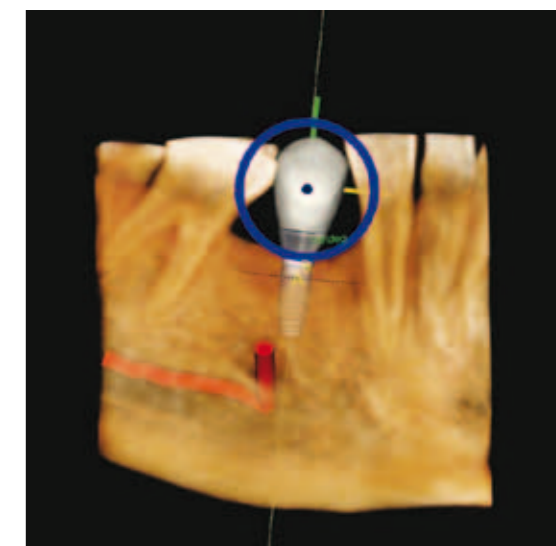

Restoration Plan



Surgical Guide



Final Restoration

## Totally Integrated Implant Solution

The GXDP-700 S offers 3D views that can be sliced in any direction – an imperative to determining anatomical variations that can affect the success of the procedure.

The GXDP-700 S integrates easily with a variety of 3D specialized restoration, digital impression, and CAD/CAM programs. Plan in a software program that allows a choice of multiple implant brands or utilize a system specific to one brand. Use surgical guides, when applicable, and milled or standard restorations. With the 3D information provided by the GXDP-700 S, you can choose solutions that meet your implant needs.

*"After more than ten years of reviewing CBCT scans for implant planning and placement, it is my opinion that the best imaging option for implant planning is Cone Beam CT."*

– David C. Hatcher, DDS, MSc  
Oral and Maxillofacial Radiologist

## 5 Easy Steps To Treatment Planning



1. Select A Patient
2. Make Touchscreen Selections
3. Position Your Patient
4. Initiate Image Capture
5. Diagnose And Plan Immediately



### Advance Your Workflow

Utilize VixWin™ Platinum for 2D imaging, and integrate with Invivo5 for 3D, for not only stunning image clarity, definition and improved diagnostics, plus fast and efficient workflow. VixWin Platinum seamlessly links and shares patient information with all major practice management programs via VxLink. With a single click, move from practice management to VixWin Platinum to capture and access to all the patient's 2D and 3D clinical images.

### Quality Products To Help Foster Life-Long Relationships With Patients

Providing solutions for dentists and clinicians — and improving the well being of patients — is our highest priority. Consistent with ALARA, the GXDP-700™ Series provides the flexibility doctors need to manage dose by taking radiographs that are tailored to body size, image type, and even pinpointing the area of interest. It also features the ability to customize dose within the allotted range. When patients question the importance and safety of x-rays, doctors can rest assured that Gendex helps them by providing a system with so many radiographic options.